

ARES

flexible endoscope

automated reprocessing system



“For the Environmentally conscious”



ARES

automated system for flexible endoscope reprocessing

“... process planning, device effectiveness, monitoring and event traceability: these are the key elements in our reprocessing system to avoid the risk of cross contaminations”

1

a critical process:

In order to maintain a correct flow through the process, it is important to create the right environment.

Steelco ARES system foresees the use of storage cassettes and a transport trolley in order to maintain the right dirty/clean flow with considerable advantages in terms of process safety.

In case the disinfection area is serving multiple endoscopes rooms, the use of the endoscope transport trolley for an aseptic movement is an additional safety aid and grants short-term safe storage improving the department productivity.

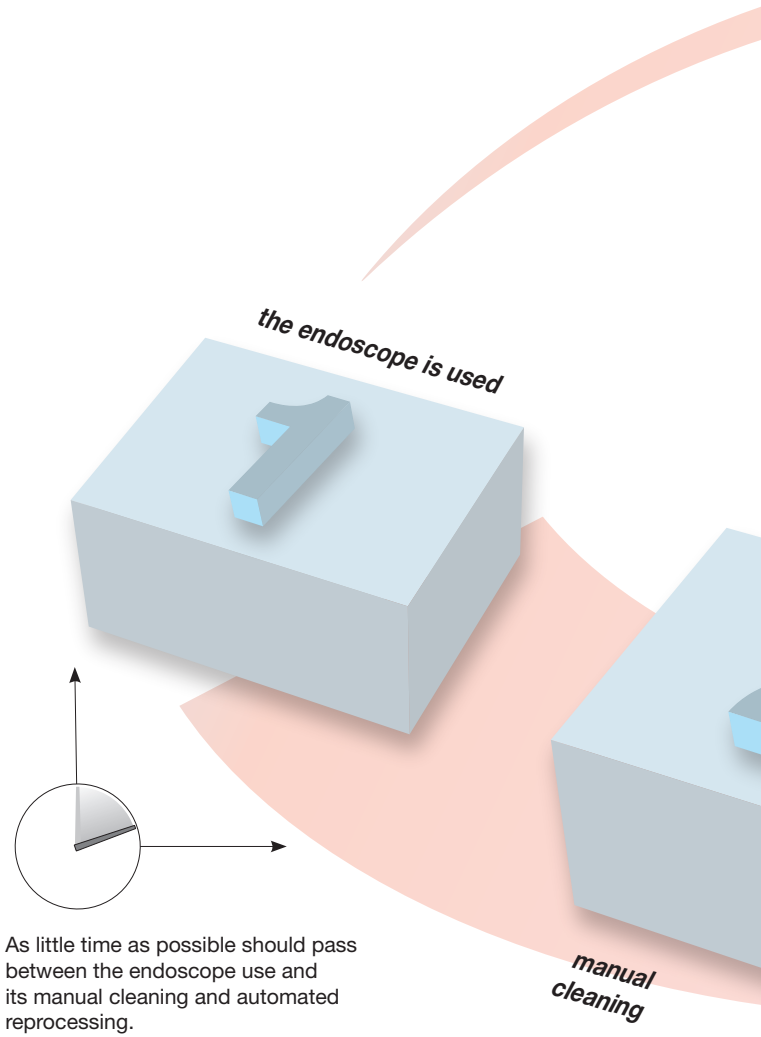

2 As little time as possible should pass between when the endoscope has been used to when manual cleaning and automated reprocessing are performed . Immediately after use, manual cleaning should be performed following the guidelines for endoscopy operators. This assures an appropriate instrument preparation for the

5 The software management system "Steelcodata" allows tracing of each process phase through automatic recording or manual data entering via a PC or through the hospital main server.

Moreover a remote connection for technical assistance can be requested in order to reduce maintenance intervention time and costs.

4 While stored in the Steelco endoscope drying cabinets, the instrument is kept under aseptic conditions which are assured thanks to HEPA filters for bacteria filtration and indirect UV light treatment.

The air flow into the internal channels of the endoscope removes any water residue in the instrument.

The constantly maintained positive pressure in the drying cabinet protects the instruments from any contamination and their horizontal position avoids stressing of the endoscope.

The endoscope can be stored in the drying cabinet for up to 72 hours. When this time is exceeded it is necessary to reprocess the instrument using a fast disinfection cycle which is among the standard programs of the EW2.

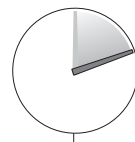

max 72 h.

process validation and endoscope usage

the endoscope is taken out from storage

endoscope storage

endoscope reprocessing

3 The exclusive Steelco endoscope drying cabinets are connected to the EW2 through dedicated software for a complete and automatic traceability with effortless control thanks to the touch screen panel.

Steelco drying cabinets are manufactured as single or double door version, with capacity of up to 8 cassettes or up to 9 tray levels for the aseptic storage of the instruments.

high level disinfection process within the AER. Furthermore, the EW2 system, thanks to dedicated chemical products manufactured exclusively by important chemical companies and to its innovative functioning, allows to reach better results than those required by the UNI EN ISO 15883.

The innovative pass-through version lets the reprocessed endoscopes to be unloaded directly in a controlled and safe area.



EW 2 - Automated Endoscope Reprocessor

Automatic endoscope reprocessor for **low temperature washing and high level disinfection of flexible endoscopes**. It is developed for the treatment of all types and brands of flexible endoscopes.

The new Steelco EW 2 machine has been developed to fully comply with the ISO 15883-4 directives and it incorporates all the latest innovative technologies.

It can be supplied in a **pass-through interlocked double door version, or single door** with overturning wing at an ergonomic height.

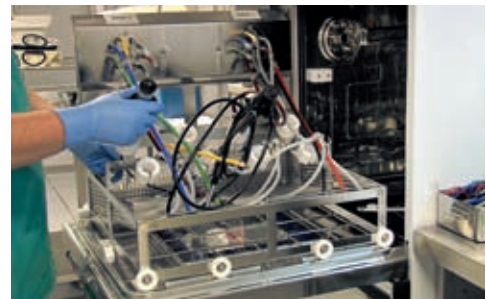

Steelco EW 2 can run the washing and high-level disinfection cycle at low temperature of 2 flexible endoscopes simultaneously.

For video bronchoscopes and fibrobronchoscopes the capacity can be even increased up to eight instruments per batch.

It also allows the process of thermal disinfection for instruments such as rigid scopes with a specific wash cart.

Pass-through interlocked double door version

The modern endoscopic reprocessing department has a physical separation between the clean and the unclean area.

Only frontal loading models are suitable for this purpose. Steelco automated endoscope reprocessor EW2 is available as a double-door model with interlocked doors. When opened, folding doors are also useful as ergonomic working surface for the connection of the endoscopes.

Steelco is one of the world's leading manufacturers of WD's for the Central Service. Our long-term experience in the field of instrument reprocessing can be easily recognized in the innovative leadership of EW 2 machine.

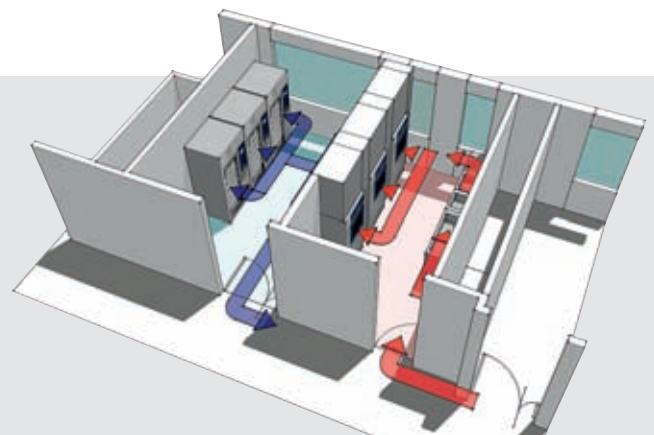

EW 2 - Unique features

- Compatible and tested with peracetic acid (cold disinfection) and glutaraldehyde (chemo-thermal)
- RFID detection of the process chemicals
- User and instrument recognition through bar code reading system or RIFD (Radio Frequency Identification).
- Precise endoscope channel-check (up to 7 channels) with two independent monitoring systems through pressure and flow measurement.
- Leak test at the beginning of the cycle and continuous monitoring during all cycle phases with automatic cycle stop in case of anomaly.
- Dedicated individual pumps, pressure and flow control for each endoscope channel.
- Individual pressure and flow channel control system with data logging during the whole cycle.
- Self thermal disinfection cycle at 90°C as required from the UNI EN ISO 15883-4 rule including endoscope basket and connections.
- Disinfection of all the water used in the process with a two stage high level water filtering (0,5 µm and 0,1 µm filters) for endotoxin removal.
- Complete **cleaning and disinfection cycle time** of 2 flexible endoscopes in **30 minutes**.
- The use of Steelco chemicals for cleaning and disinfection guarantees highest microbiological efficiency and documented results in the instruments biofilm removal
- Integrated sterile air filter for channel leak test, purging and drying.
- Data logging of all program data and instrument parameters, graphically visualized as a curve.
- Large color LCD touch screen display for easy machine operation and endoscope/operator database management.
- Complete documentation on integrated printer or to PC/hospital server with SteelcoData software.

Optional

- Drain pump
- Conductivity sensor
- Light inside the chamber
- Remote control assistance
- RFID sensor for instrument/ operator recognition
- Bar code reader for instrument/ operator recognition
- Steelcodata software for data management and devices remote monitoring
- Increased total power for reduced disinfection cycle time
- Oil free air compressor (requires medical compressed air filtering system)
- Medical compressed air filtering system (for air compressor or connection to no medical quality compressed air source)

Dimensions and connections

Standard electrical connection (International)*	400V/3~+N/50Hz
Optional electrical connection (North America)	208V/3~+N/60Hz
Power	6050 W
Noise	62,4 dB(A)
Permitted room temperature	+5°C/41°F - +40°C/104°F

*other available connections: monophase 230V/50Hz with total power reduced to 3550 W
triphase 400/50Hz with increased total power and reduced disinfection cycle time

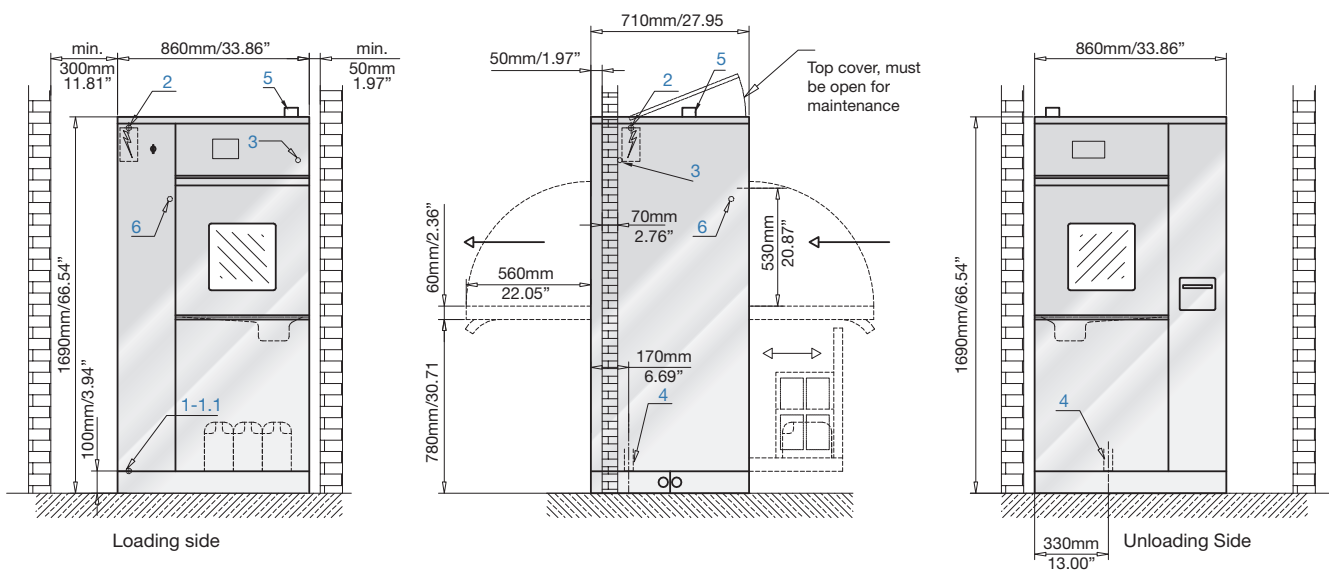

1 Demineralized water connection	¾" male	DN 20 mm	3 Medical compressed air connection	¼" male - ø8 mm pipe holder
1.1 Cold water connection*	¾" male	DN 20 mm	4 Machine drain	1" female DN 25 mm
2 Electrical connection			5 Chamber exhaust pipe connection	Ø 60 mm

* to be used if demi water is not available



EW 2 - Washing carts

C558 rotating wash cart for 2 flexible endoscopes

Steelco Patented rotating wash cart for flexible endoscopes has been developed for **effortless general operation and also for restricted space areas.**

The rotation of the cart assures a frontal insertion of both instruments making the connection of the washing channels easy.

The process is separately controlled for each instrument.

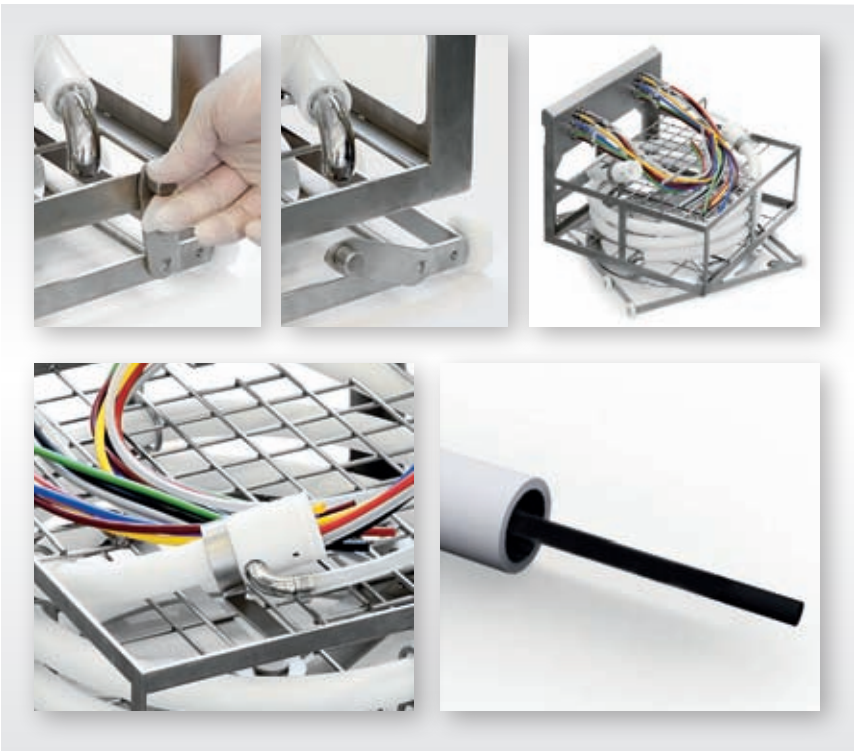
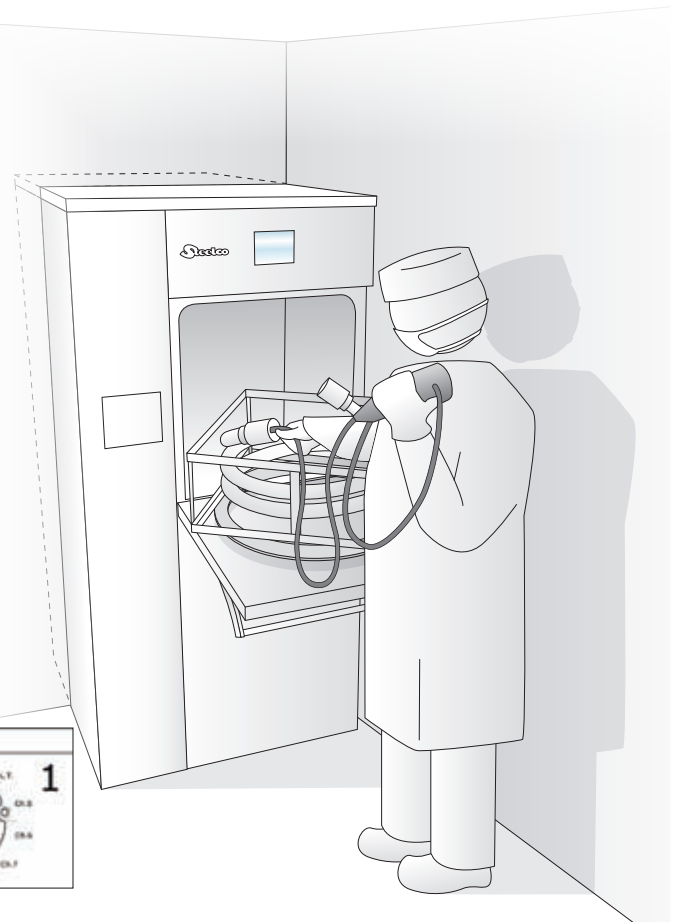
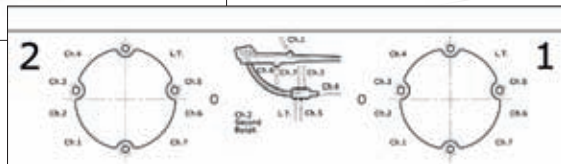
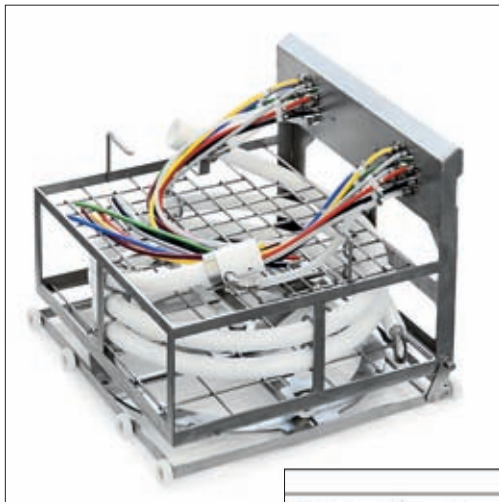

Locking device

The alignment of the cart for a proper working position is assured by a one way locking device.

External surface cleaning

A dedicated system ensures the safe storage of the instrument during the process and a complete disinfection/sterilization of the external surface of the endoscope.

C559 wash cart with baskets for 2 flexible endoscopes



Steelco has manufactured a 2 levels basket that allows the simultaneous treatment of 2 flexible endoscopes which can also be easily used in areas with restricted space.

The removable tray can be used for the no-contact transportation of the endoscope to the ED 100/200 cabinets for drying and storage.

The endoscopic instrument should be placed within the removable basket preventing the contact between the parts of the endoscope that can generate areas unreachable by washing/disinfection.



The accessory C565 avoids endoscopic instrument overlapping points, places the connection tube and the distal tube in a constant slope to facilitate the natural drain of fluids from the channels.

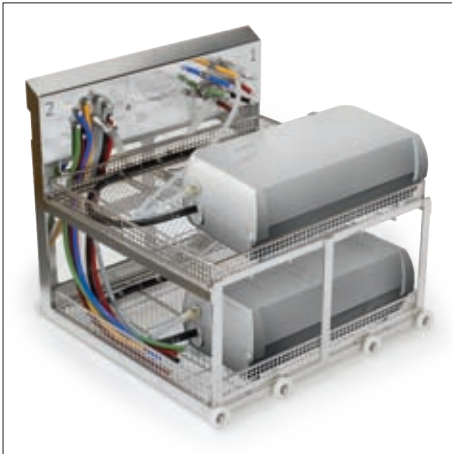

SAFE CASE for compliant and validated TEE probe reprocessing

With Steelco SAFE CASE the electronic control and connection cable are placed inside an hermetic case and isolated from the distal tube that requires a complete washing cycle and a high level non thermal disinfection.

The whole package can be placed inside a washer disinfector where an automatic, compliant and validated reprocessing cycle can be executed.

To be used with a 2 level cart C559 to allow the simultaneous treatment of 2 transesophageal probes.

C560 - video bronchoscope, fibrobronchoscope wash cart



Wash cart for the simultaneous treatment of: 4 videobronchoscopes/ cystoscopes or 8 fibroscopes/ cystoscopes with separate control.

This innovative system allows to save money but with the high process safety. Standard cycle 5 minutes at 35°C, high level disinfection cycle that can be tested with biological indicators.

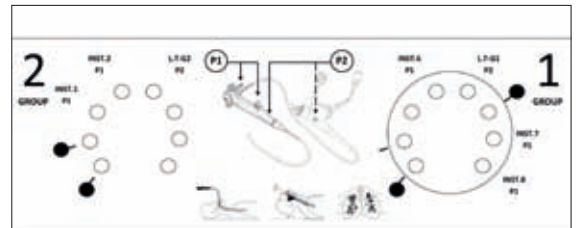



EW 2 - Washing carts

C563 rigid scopes wash cart



Wash cart for nr. 20 rigid scopes with the possibility of luer lock connection for washing.

In accordance to the UNI 15883/1 guideline and coherent to an environmental conscious behaviour Steelco strongly recommends to apply thermodisinfection process for all reusable medical devices that can be high temperature treated. EW2 endoscope reprocessor machine can run a standard thermal disinfection cleaning program.

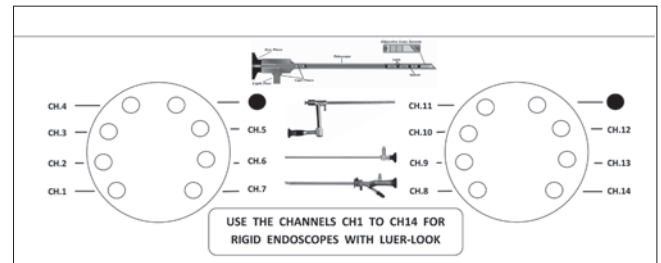

C568 endoscope storage cassettes wash cart



Wash cart for nr. 2 endoscope storage cassettes.







Conformity to UNI EN ISO 15883

Steelco EW2 is fully complying to the UNI EN ISO 15883-1 and UNI EN ISO 15883-4 and incorporates the most advanced technologies in this field.

The process has been validated by some of the most important microbiological institutes.

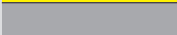

EW 2 - Endoscope connections

	channel	bioptic 1
	channel	bioptic 2
	channel	water
	channel	air
	channel	suction
	channel	elevator
	channel	aux water/CO ₂
	leak test	

Connection scheme

The number and kind of connections change from scope to scope. Colour coded connection for easy identification of each individual channel.

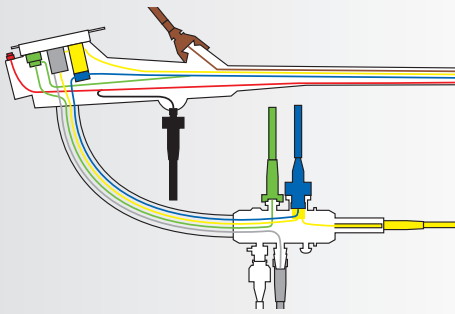

Channel connections

A typical connection scheme is also impressed on the washing cart for operator's aid. Endoscope position is easily identified by a number.

Cart/washing machine coupling system.



Connection hoses

The connection hoses used in the EW 2 are flexible for easy attachment of the adapters to the endoscope and crimped thus avoiding unnecessary interruptions of the treatment program.

Hoses are made with FDA-approved materials to offer protection against biofilm and can be disinfected both chemically and thermally (EW2 self disinfection cycle at 90° C).

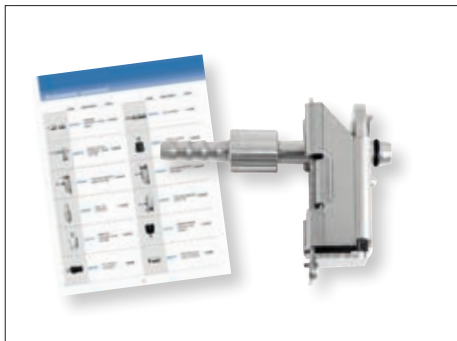

Adapters and connectors

The ARES program includes a complete range of manufacturer-specific connectors for the endoscopes reprocessing.

The products are characterized by a high quality manufacturing for longer life and to ensure the tight connection to the cleaning system without pressure loss. The Steelco adapters range includes connectors for virtually all flexible endoscopes from all manufacturers.



EW 2 - standard cycle description

Leak test during the whole cycle					
*	1- pre wash				
		*	2- main wash		
				*	3- first rinse
					*
				4- high disinfection	
					*
				5- rinse	*
					* sterile air channel purging

This is required to remove chemical residues from manual washing and to remove contaminant agents

This is required to remove organic residues and microbial biofilm

Rinse from the chemical residues of the previous main wash

The standard program for high level disinfection grants a 5 minutes cycle at 35°C/95°F

Rinse phase with 0,1µm filtered water (medical device) to assure a process with sterile water and without endotoxines. Additional rinses (opt.) with sterile filtered water from the EW2 high level water filtering system

Water residues removal from the endoscope internal channels.

* EW2 performs sterile air channel purging before every single cycle phase

RFID)))



neodisher® is a registered trademark of Dr. Weigert GmbH & Co.KG

Optimal performance with Steelco process chemicals

In cooperation with the market leading manufacturer for process chemicals used in instrument disinfection Dr.Weigert GmbH & Co. KG, neodisher® products were configured specifically for the Steelco EW2.

Steelco has implemented (first in the market) the use of RFID technology for the identification of the process chemicals together with the registration of the lot number and expiration date. An important safety application that keeps the process monitored and documented also in this often neglected aspect.

Steelco neodisher® SC

This product guarantees the excellence in cleaning performances and protection of the materials even at dosing temperature of 35°C/95°F.

Steelco neodisher® Septo PAC

Based on peracetic acid, this disinfectant chemical has a broad spectrum of activity providing secure and fast processes with the best material compatibility.

neodisher® Mediklar

The use of this rinsing agent improves the drying results of the instruments.

By using Steelco process chemicals the EW 2 automatic endoscope reprocessor reaches the highest efficiency results proven by microbiological tests together with complete documentation and instruments maximum safety conditions.



Water filter second step
0,1 micron 10 inches



Water filter first step
0,45 micron 10 inches

Final rinse sterile water

The double-stage microbiological filtration system not only secures the validated disinfection of process water for the final rinse phase, it also disinfects the amount of water needed for the whole cycle, so that the spread of germs from the site water supply in the endoscope reprocessor is totally excluded.

Filters performances of are continuously checked providing maximum security.

Filters are decontaminated during the thermal self-disinfection program of the machine thus guaranteeing a long time service life. Both filters are approved medical devices.

The most advanced controller, the easiest interface, the safest system.

The EW2 is controlled by a last generation PLC which communicates with a redundant system of probes for temperature control, chemical dosing and water consumption. For additional functioning security it is foreseen a second electronic board.

A 5,7" touch screen panel lets the operator interface.

The system access is protected by a 3 levels password (installer - maintenance technician - final user) and requests operator identification to enable the washing cycle programming or their own start.

The software manages a database of endoscopes.

At the first start of the machine the technician associates to each instrument the relevant elements for its identification, i.e. manufacturer, type, model and the parameters related to flow and pressure, number of active channels, pump functioning mode.

The standard features of the EW2, and the optional bar code reader or RFID sensors avoid the risk of human error for the identification and selection of the disinfection program.

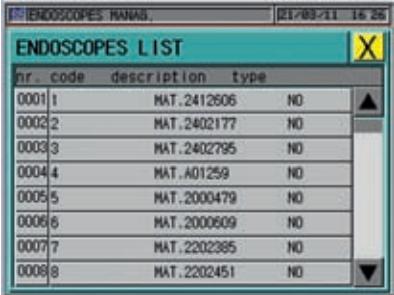

nr.	code	description	type
0001	1	MAT.2412606	NO
0002	2	MAT.2402177	NO
0003	3	MAT.2402795	NO
0004	4	MAT.A01259	NO
0005	5	MAT.2000479	NO
0006	6	MAT.2000609	NO
0007	7	MAT.2202385	NO
0008	8	MAT.2202451	NO

The startup screen of the cycle is simple and, in case of automatic recognition of the instrument, the cycle start is almost immediate.

The graphic interface is very similar to the drying and storage cabinet one as well as to the Steelcodata software one.

From when the cycle is started the progress of the cycle will graphically be shown and the parameters referred to time remaining for phase and cycle completion will be displayed.



BARCODE
or
RFID)))



Operator:	DARTO
Choice:	MIXED
Pr. type:	ENDOSCOPES
Instr1: 003 INST. ECOENDO Type GASTROSCOPE Man. STORZ Chann. 1 2 3 4 5 6	Instr2: 004 INST. PEDIATRICO Type COLONSCOPE Man. OLYMPUS Chann. 1 2 3 4 5 6
P. 003STANDARD PERACET	P. 003STANDARD PERACET

During the instrument reprocessing cycle, the EW2 display allows the visualization of:

- General state of functions
- Active parts
- Temperature trend and leak test
- Selection of the 4 synoptic for the visualization in real time of sensitive parameters such as channel active pumps, channel flows, channel pressures, temperature, etc.

All parameters are recorded for later processing and storage.

The Steelcodata software and the Steelco medical devices control panel interface are available for the mainly spoken worldwide languages: English, French, Spanish, German, Dutch, Italian ...



Instrument 1	Instrument 2
318mb / 505ml / 442ml / 311ml	
248mb / 315ml / 442ml / 326ml	
686mb / 189ml / 126ml / 1097ml	
1138mb / 126ml / 126ml / 715ml	
270mb / 442ml / 442ml / 326ml	
986mb / 126ml / 126ml / 989ml	
957mb / 126ml / 126ml / 1006ml	



ED 200 - Drying and storage cabinets for endoscopes

After being reprocessed in the EW 2, the endoscope is ready to be used or to be stored in the ED series drying cabinets which protects endoscopes from any recontamination.

Warm sterile air is used to blow through each internal channel and over all surfaces to rapidly dry both the inside and outside of the flexible endoscopes while they are in the cabinet. This ensures that endoscopes are well ventilated at all times.

The endoscope internal channels are connected to the drying circuit through specific quick connectors.

Up to 8 endoscopes can be stored at a time in cassettes or in baskets with lower trays for water dripping.

The process allows the storage of endoscopes up to 72 hours after full washing and reprocessing with no need to reprocess them again.

Steelco ED drying cabinets can be fitted with a bar code reader and printer for logging scopes in and out ensuring full tracking and traceability of the scopes.



ED200 PLC version with touch screen display

NO	ALL ID	INSTRUMENT STATE	01-05-11 17:09
C: 41.0 °C DOOR OPEN E: 40.8 °C			
1	001 EG-530N	71.59	
GASTROSCOPE FUJI			
2	002 CF-Q180AL	1.59	
DUODENOSCOPE OLYMPUS			
3	003 PCF-Q180AL	70.53	
COLONOSCOPE OLYMPUS			
4	006 81F-TQ160	0.00	
GASTROSCOPE OLYMPUS			
5		0.00	
6	012 CF-Q180AL	50.19	
DUODENOSCOPE OLYMPUS			
7	018 CF-Q180AL	61.39	
DUODENOSCOPE OLYMPUS			
8		0.00	

- Model, instrument code and position into the cabinet are displayed.
- Interlocked doors controlled by PLC (double door pass-through version).
- Events and cycle data storage for each instrument treated, for all machines parameters.
- Process print.
- Ethernet connection for PC data storage or Steelcodata.
- Working cycles can be programmed.

ED 200 is also available with 8 endoscopes horizontally placed inside baskets with lower trays for water dripping.



ED 200 - Physical characteristics

- Capacity: 8 endoscopes stored into cassettes 540 mm width x 500 mm depth (21.26" x 19x68").
- Supplied as standard version with n° 8 cassettes and endoscope fast connections.
- Door made in HST temperate glass.
- Frame and panels in stainless steel AISI 304.
- Glass lockable doors are reversible and therefore can be configured right or left opening also during installation.
- Single and double door (pass through) versions with control panel controlled locking.
- High level HEPA H14 air filtering.
- Indirect UV air treatment.

Main optional features

- Cabinet configured with 8 net baskets with lower trays for water dripping
- Compact frame combining two devices into a single unit
- Integrated printer ST3
- RFID sensor for instrument/operator recognition
- Bar code reader for instrument/operator recognition
- Indirect UV drying air treatment

Colour-coded cassettes with cover for the transport and the storage of the instruments.



Connection system cassette/cabinet and cassette/endoscope.



Storage for large endoscopy centres

Endoscope storage is a big issue for large endoscopy centres with high instrument throughput. Storage space saving is a must and a great advantage.

The ED 200 can be configured in a more compact frame that combines two devices into a single unit with central control module. In an installation width of only 1672 mm / 65.82", up to 16 flexible endoscopes can be simultaneously dried and stored.

Compared to conventional vertical storage the horizontal storage capacity is increased significantly and material damage caused by "stretching" of the endoscope external surface is avoided.

Capacity comparison: vertical & horizontal storage

typical **vertical storage** type cabinet footprint

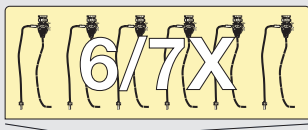

Steelco **ED 100**

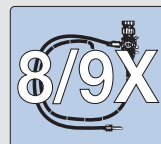

Steelco **ED 200**

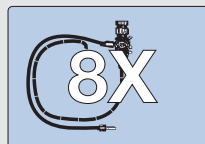

Steelco **ED 200** equipped with compact frame combining two devices into a single unit

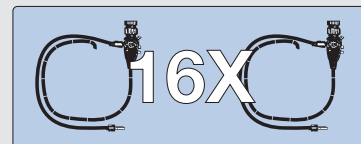



Connections

Standard electrical connection (international)	230V/~ /50Hz
Optional electrical connection (North America)*	110V/~ /60Hz
Power (each storage cabinet unit)	2000 W
Noise	< 48.5 dB(A)
Permitted room temperature	+5°C/41°F - +40°C/104°F

*other electrical connections also available as optional

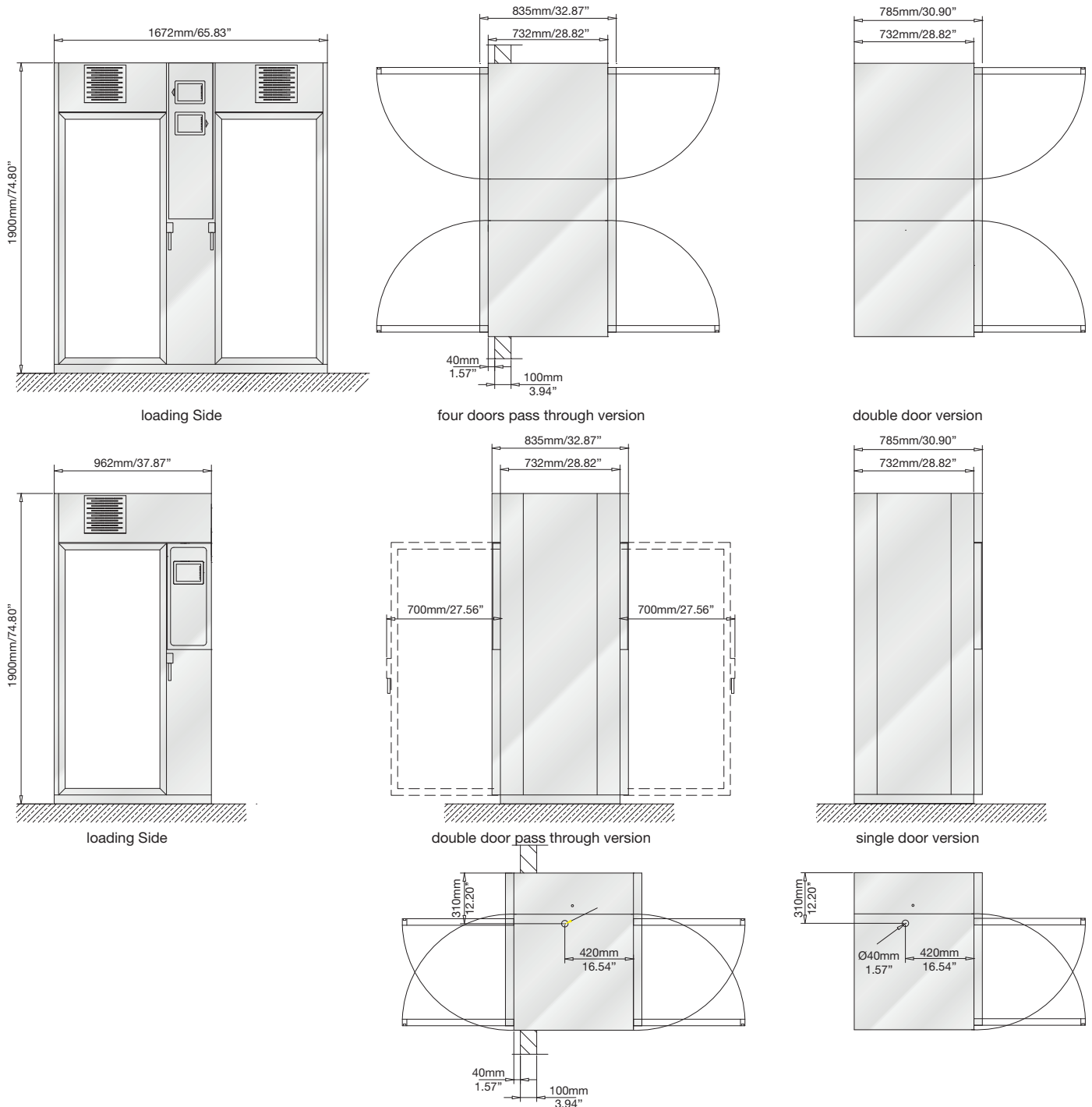

Dimensions

Weight

200/380 Kg

ED 100 - Drying and storage cabinets for endoscopes



Characteristics

- Capacity: up to 9 endoscope net baskets 460 mm width x 520 mm depth (18.11" x 20.47"). With lower tray for water dripping.
- Supplied as standard version with 8 net baskets and 8 fast air connections for endoscope instruments.
- Frame and panels in stainless steel AISI 304.
- Door made in HST temperate glass.
- Glass lockable doors are reversible and therefore can be configured right or left opening also during installation.
- Single or double interlocked doors pass through versions. Double door version opening depends on control panel. Single door version can be key locked.
- High level HEPA H14 air filtering
- 3 programmable cycles

Main optional features

- Indirect UV air treatment
- Integrated printer ST2
- Cabinet equipped with 9 shelves and cabinet/endoscope connections

Dimensions and connections

Standard electrical connection (international)	230V/~/50Hz
Optional electrical connection (North America)*	110V/~/60Hz
Total power	1850 W
Noise	< 45 dB(A)
Permitted room temperature	+5°C/41°F - +40°C/104°F
Weight	187 Kg

*other electrical connections also available as optional

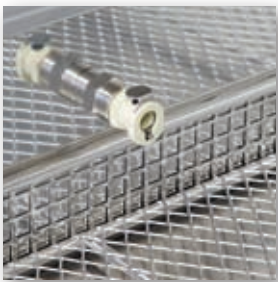
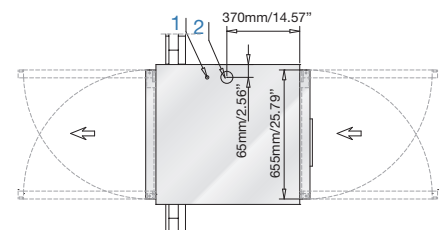
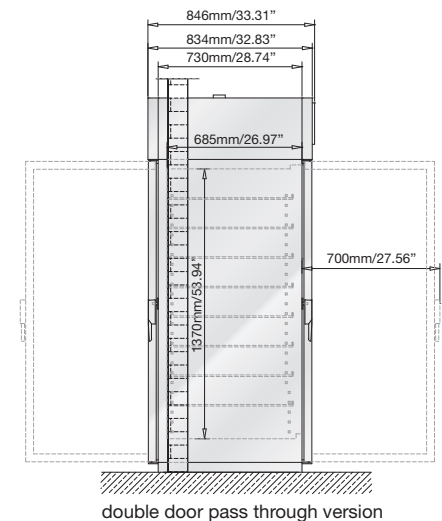
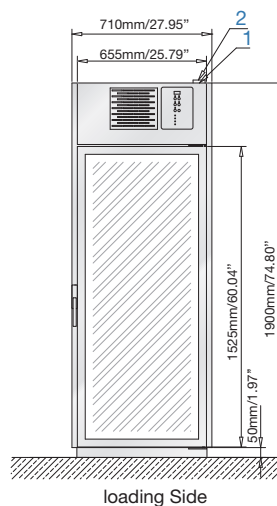

Cabinet/endoscope CPC fast connection system.



Universal endoscope channel connectors are provided for every cabinet level.



Process planning and safety aids

In order to maintain a correct flow through the process, it is important to create the right environment.

Steelco ARES system foresees the use of storage cassettes and a transport trolley in order to maintain the right dirty/clean flow with considerable advantage in terms of process safety.

In case the disinfection area is serving multiple endoscopes rooms, the use of the endoscope transport trolley for an aseptic movement is an additional safety aid and grants short-term safe storage improving the department productivity.

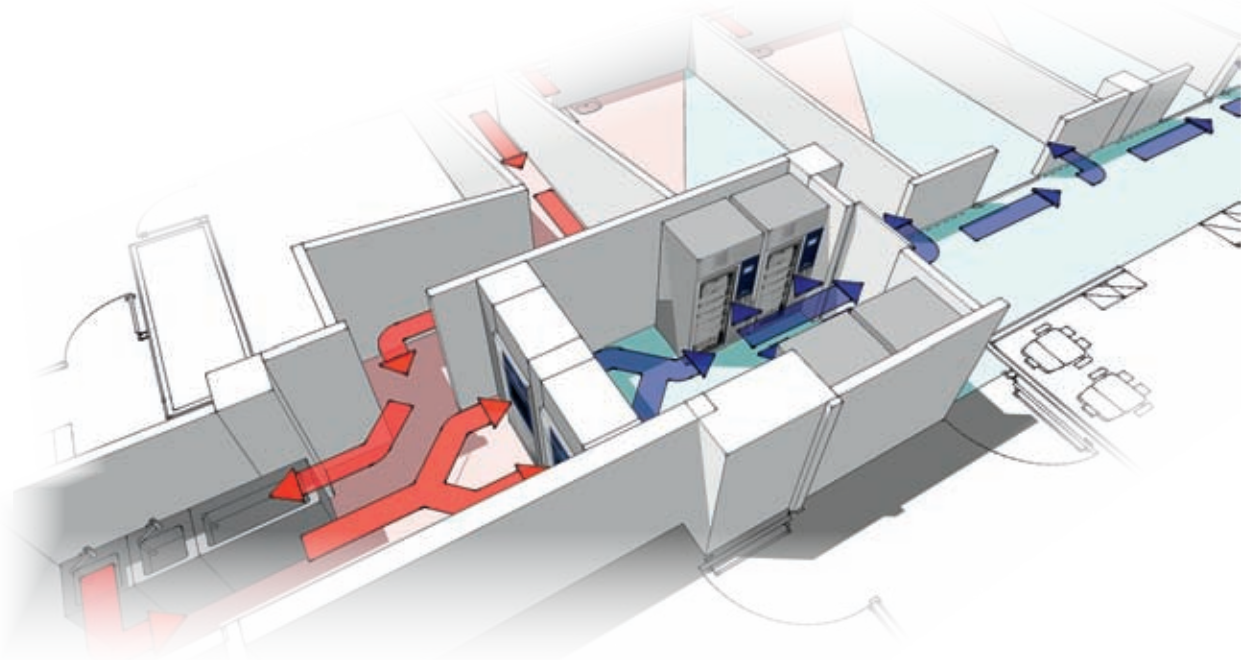

C 256 Transport and short time storage of contaminated/disinfected endoscopes and accessories

Transport trolley on wheels with capacity of 4 cassettes.

It is completed with bag holder with red and white bags for dirty or clean instruments.

Made of stainless steel it can also be used as a support for the endoscopes.

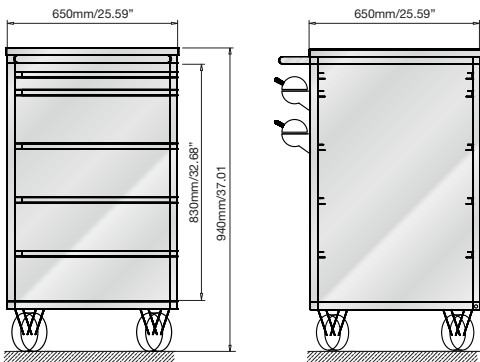

Dimensions

Weight

45 Kg

High safety procedure

- 1 Prepare an empty container
- 2 Put the red bag in the container
- 3 Put the endoscope in the container
- 4 Close the red bag with the handles
- 5 Close the lid and turn the switch to red
- 6 Washing and disinfecting endoscopes
- 7 Prepare an empty container
- 8 Put the white bag in the container
- 9 Put the disinfected endoscope in the container
- 10 Close the lid and turn the switch to green

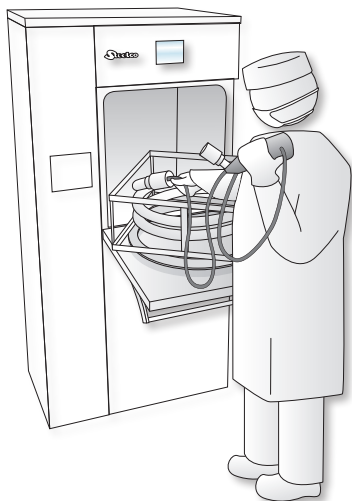

endoscope reprocessing

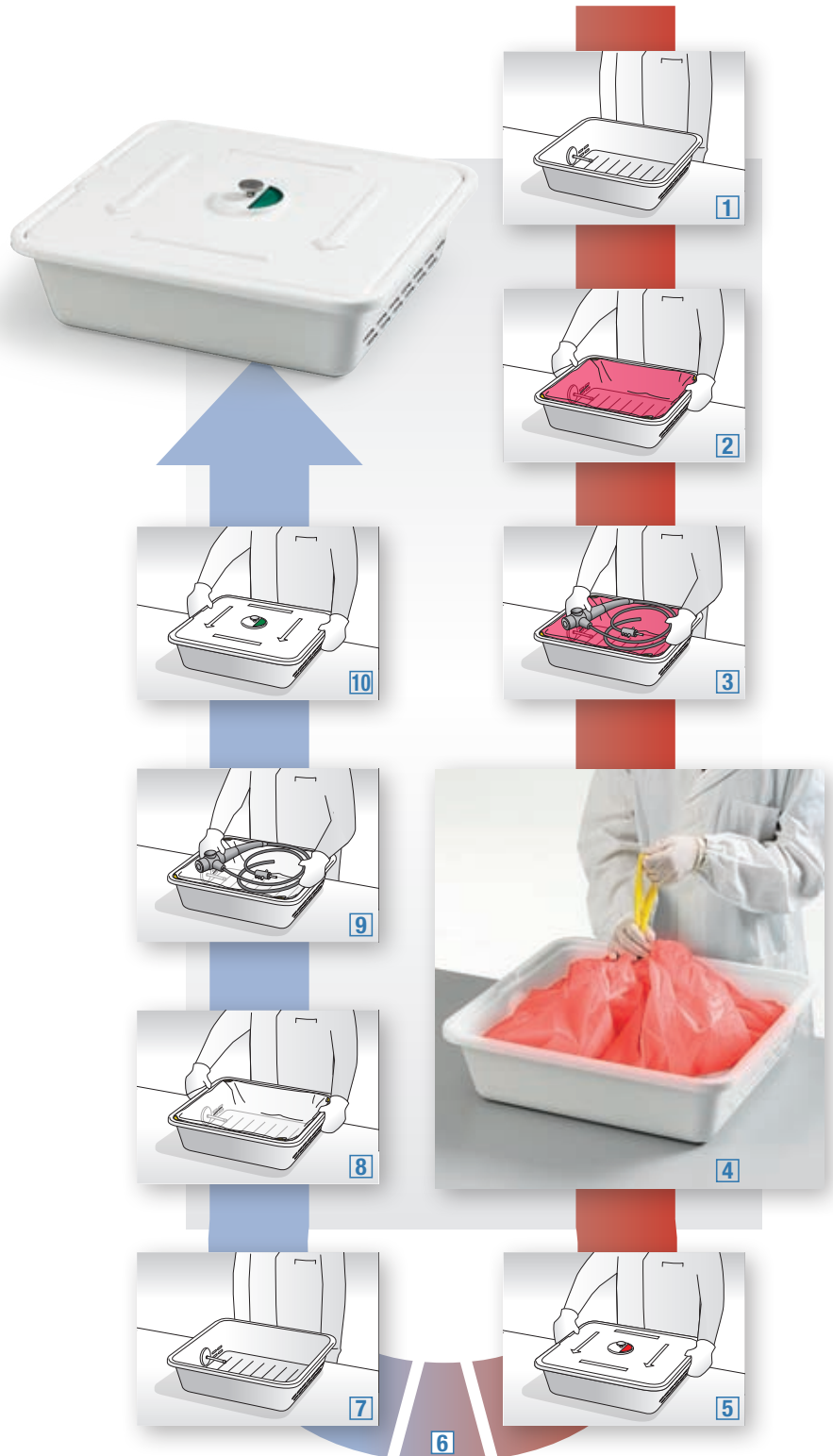



Steelcodata - Data management and remote monitoring of the devices

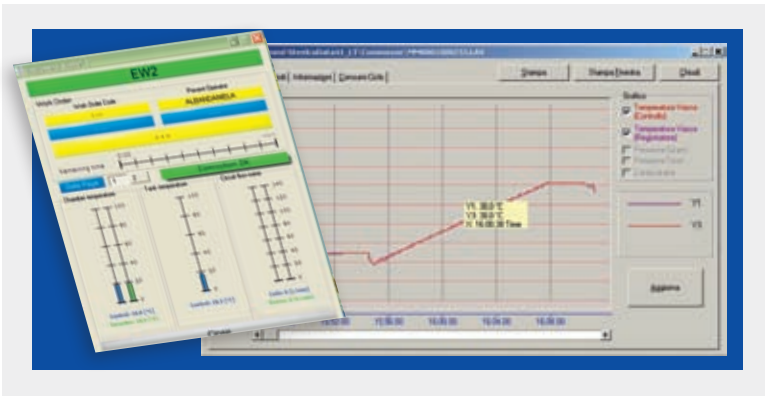

Main Features

- > Steelcodata is a powerful software package with a very easy and complete operator interface. Its aim is mainly to **visualize the running cycles, to easily manage and store the information** generated by other devices configured in the system and allows also the **immediate remote monitoring of the machines**.

It is available for Windows and the connection is made through the Ethernet in order ensuring full transparency and compatibility with the customer resources, keeping all the cycle data stored for legal purposes and for statistics visualization.

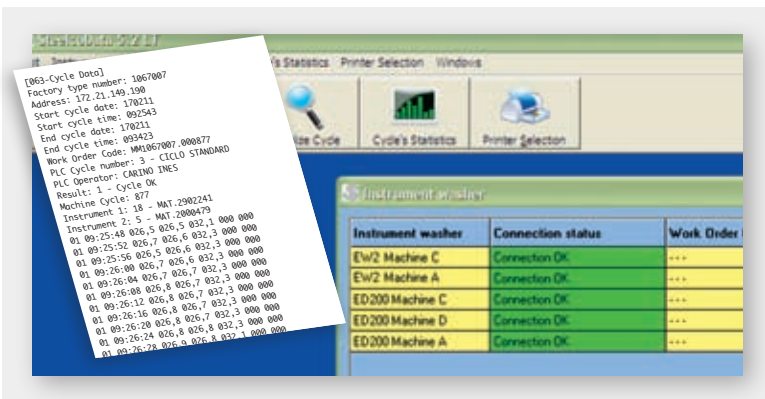

Complete storage of the registered data

- > Every 4 seconds the Steelcodata collects all the registered records from each device and processes them by **providing visual information summary which can immediately be interpreted by the operator**. All data even if not visualized on the summary display will be available for **local back up or remote back up into the hospital server**. In the event of any connection interruption with the server, the devices can continue to operate and all the records will be automatically transferred when the communication will be restored.



Cycle consumptions and statistic functions

- > Specific screens are dedicated to the information on **cycle consumption** of water, chemical products and to the alarm history. Steelcodata can work simultaneously with several opened windows thus allowing an **immediate visual comparison of the data and charts** from different machines.

A specific menu is dedicated to statistical functions in order to search and control cycles and reprocessed instruments. It is possible to search for instrument serial numbers or for process identification number.



Information security

- > The Steelcodata software makes accessible to the operator the main data of the executed washing cycles, of times and storage of the endoscopes (available with the ED 200 Steelco drying cabinets only), allowing to select and export them in 2 different formats, one that cannot be modified and usable only for legal reasons, and the other one for compatibility to other management and traceability systems.

Steelcodata allows to print on adhesive labels which can be easily applied on the patient documentation or to use a normal A4 page printer.

ARES - SteelcoData control system



Steelcodata control system was created to meet the need of traceability and phase control, both manual and automatic, in order to avoid any human error and assure the use of only correctly disinfected and not contaminated instruments on patients.

The validation print out document provides an absolute guarantee that the instrument reprocessing has been done successfully and all the cycle information is supplied for full traceability.

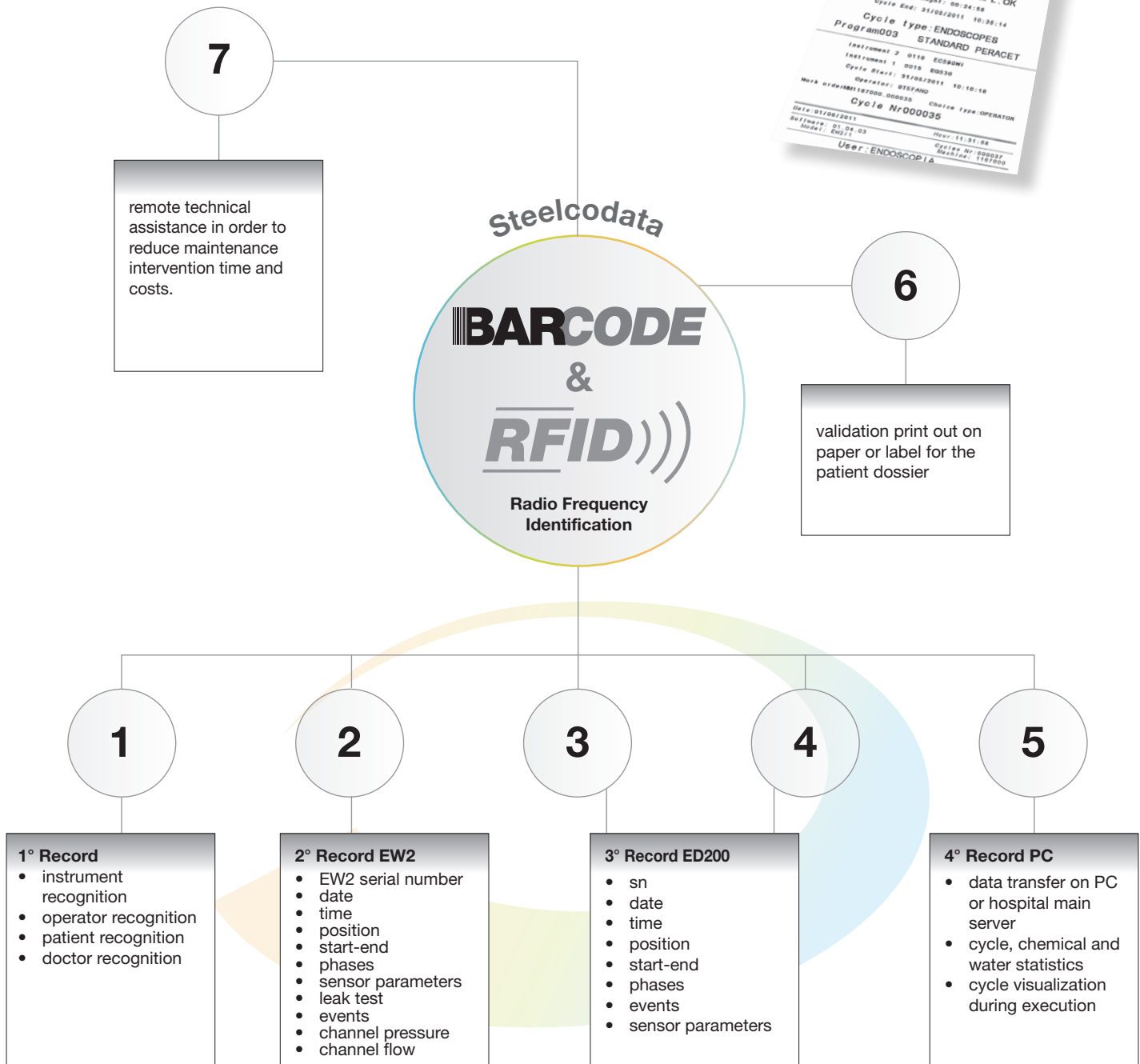

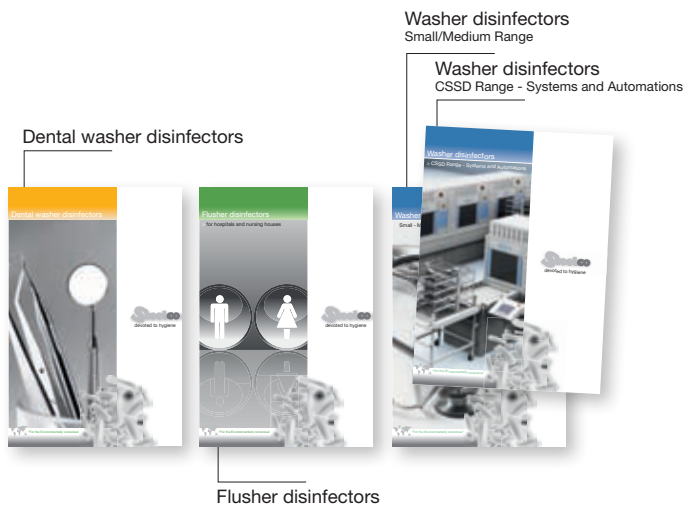

www.steelcospa.com



Headquarter

STEELCO S.p.A.

Via Balegante, 27 - 31039 Riese Pio X (TV) - Italy
Ph. +39 0423 7561 - Fax +39 0423 755528
e-mail: steelco@steelcospa.com
www.steelcospa.com

Branches

STEELCO HUNGARY

Temesvár u., 19-21
1116 Budapest - Hungary
Ph. +36 1 371 0257
Fax +36 1 371 0258
e-mail: steelco@t-online.hu

STEELCO USA

999 Stinson Way - Unit 301
West Palm Beach, FL 33411 USA
Ph. +1 561 791 8313
Fax +1 561 791 8213
e-mail: contact@steelco-usa.com

STEELCO ASIA

6th floor, Suite 16, IOI Business Park
Persiaran Puchong Jaya Selatan - Bandar Puchong Jaya
47100 Puchong, Selangor - Malaysia
Ph +60 3 8064 4339 (Ext. 112) - Fax: +60 3 8064 4340
e-mail: adminasia@steelcospa.com



Products offered for sale may differ from those described or illustrated in this brochure due to later production changes or/and optional configurations. The products and technical specifications are subjected to change without prior notice. Please consult your Steelco dealer for the latest information.

DC-PD-02-ARES EN Rev.04